

Bay series

BS-200W-BA-DW-90

SUPER PRO VOLTRON® LED BAY (200W) - 7 years warranty.
 Industrial luminaire with the accent on its unique cooling capacity.
 LUMILED chip SMD3030 - 4000K - IP65 - 29.322Lm (140Lm/W) - L80 >72.000h - MeanWell Driver included (dimmable 7 year warranty)
 - Interchangeable power supply and light source - ENEC approved -
 For industrial applications for heights from 6m .

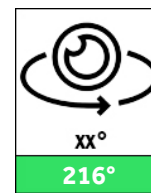
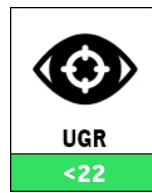
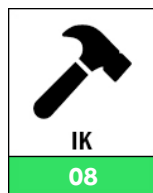
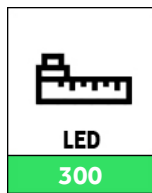
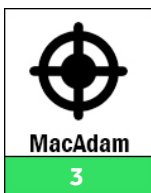
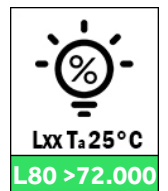
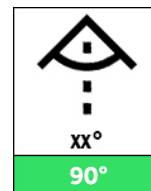
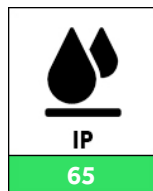
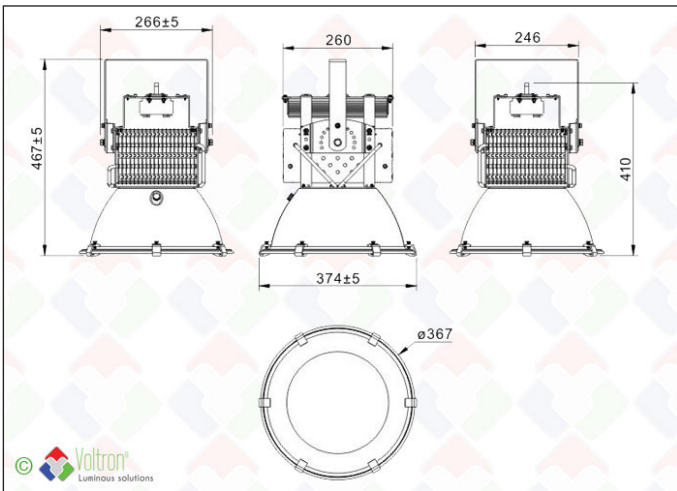

Technical data

Productnumber	Barcode	CCT	IP value	Led chip
BS-200W-BA-DW-90	LH-1420	4000K	65	SMD3030
Number of LED	Wattage	Height	Diameter	Finish color
300	200W	46,7CM	36,7CM	Black
CRI Ra	Lxx @Ta=25°C	UGR	MacAdam	IK
>80	L80 >72.000	<22	3	08
Spread angle	Tilttable	Lumen	Dimmable	Driver included
90°	216°	29322Lm	V	V
Gross weight	Net weight	Constant current	Packed per	
7500GR	6000GR	V	1	

Specification text*

LED fixture for industrial applications ENEC and TÜV Rheinland approved. The fixture is constructed according to the circular principle: power supply and light source can be replaced quickly and easily. This fixture can be hung directly from the ceiling by means of the special bracket. There are 12 positions on the bracket. The bracket can be turned up to 216°. The housing is provided for 4 external copper heat pipes and a special copper base plate for the PCB as maximum heat dissipation. The light cover is equipped with an atmospheric air pressure control so that condensation or moisture can be removed immediately. The 90° lens reflects up to 92% of the initial light. The housing is equipped with 4 top technologies: HDT (Heat Deflection temperature), FIN FASTENING (direct heat dissipation from LED and PCB), ZIPPED-FINS (a large number of thin cooling fins has been set up so that natural air displacement can cool the luminaire much faster than traditional fixtures), SEAMLESS FITTING (connections without opening). Equipped with 300 LUMILED chips. External reflector of 90° with laminated glass to protect the LED. LED power supply of type MeanWell HLG-240 with 7 year warranty, Class I, Division 2 with an efficiency of up to 94%, 4kV surge immunity level (IEC61000-4-5). Dimmable: 1-10V / resistance dimming / PWM signal. LED power supply is mounted externally for faster connection. Luminaire luminous flux of 29322Lm. Efficiency of 146.61 Lm / W. Color rendering index of > 80. Light color 4000K daylight white. Luminaire body complete in high-quality aluminum with a black lacquer layer. IP65 class. Equipped with heat reporting, photo metric report, IES file for elaboration in DIALux. L80 > 72,000 @Ta = 25 ° C. Salt test: 96 hours, 5% neutral salt fog, salt spreading pressure = 1.0 kgf / CM, pH 6.5 ~ 7.5, salt quantity: 1 ~ 2 ml / 80 cm², Ta 35 ° C, salt spray temp = 47 ° C. ENEC and TÜV Rheinland approved.

* Available on the website

Photometric diagram

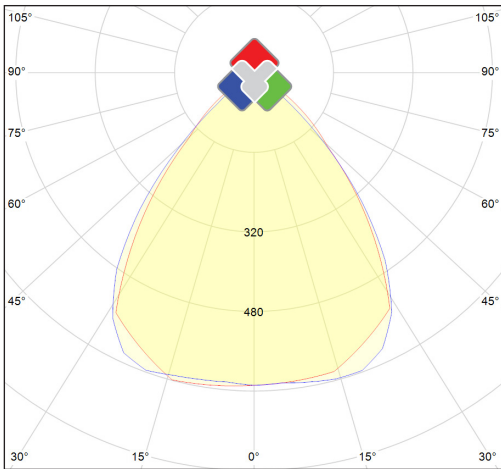

Areas of application

Production areas with open structure / open warehouses, halls, ... / perfect 1 to 1 replacement for existing HQ lamps

Extra information

All information, specification texts, photos, technical drawings, connection diagrams, photometric .LDT files can be found via this clickable direct link: https://www.voltron-lighting.com/product/EN/71/1420/Bay_series--BS-200W-BA-DW-90 or can be requested through your contact person.

Direct link website



Product barcode



The Voltron® name and logo as well as product names are part of the Voltron® Lighting Group and are protected by national and international laws.

The usage rights, reproduction rights as well as the intellectual rights are the exclusive property of the Voltron® Lighting Group.

Voltron® pays a lot of attention to the correctness and completeness of the information. However, it cannot be held responsible for any inaccuracy and / or omission. All images and texts are protected under copyright law and may not be used or multiplied without express permission.