

# LED Eco Smart Controllers

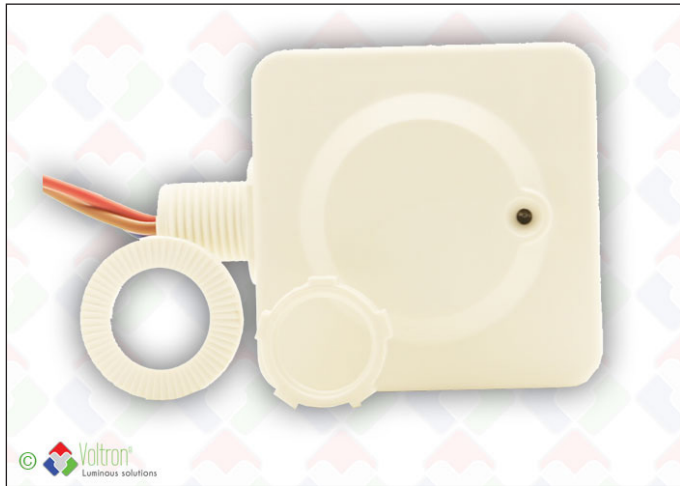

## SDS2

VOLTRON® SDS2 Eco Smart Controllers is a built-in detector with adjustable detection range, switch-off time and daylight sensor. Adjustable with DIP switches on the back of the sensor. Possibility to install as master/slave. Detection range of 12 meters diameter with a suspension height of 6 meters. Detection radius range of 9 meters when mounted in a vertical wall at 4 meters height. Maximum installation height of 12 meters. 800W capacitive power. Max standby consumption of <0.5W. Detection radius adjustable at 10/25/50/75/100 percent. Equipped with a switch-off delay 5s/30s/1min/5min/10min/30min. Daylight sensor to be set to : 2lux/10lux/30lux/50lux or switched off. Class IP20. Can be used in an ambient temperature between -20°C and +50°C. Always 5 years warranty.

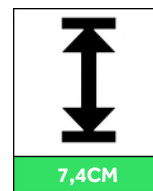
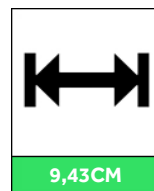
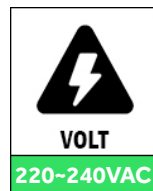
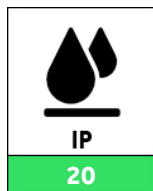
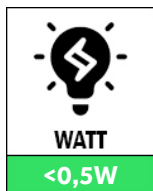
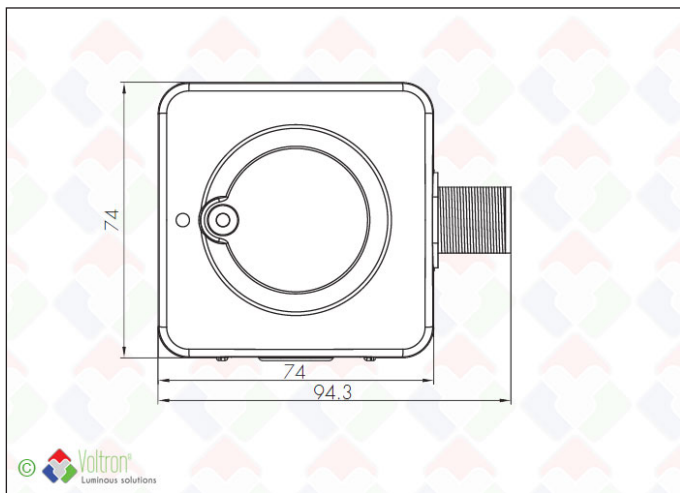

## Technical data

Productnumber	Barcode	IP value	Voltage	Wattage
SDS2	LH-1229	20	220~240VAC	<0,5W
Length	Width	Height	Diameter	Finish color
9,43CM	7,4CM	3,3CM	-	White
Packed per				
1				

## Specification text\*

Surface-mounted detector with adjustable detection field, waiting time and daylight sensor. With a height of 3.3CM height, a length of 9.43CM and a width of 7.4CM. Adjustable with dip switch on the back of the sensor. Hanging at a height of 6 meters, the detection radius is 12 meters. Mounted in a vertical wall at 4 meters height = 9 meters distant detection radius. Detection radius can be set to: 10% / 25% / 50% / 75% / 100%. Wait time can be set to: 5s / 30s / 1min / 5min / 10min / 30min. Daylight sensor can be set to: 2lux / 10lux / 30lux / 50lux or switched off. Maximum load on 230VAC is 800W capacitive. Next works with Microwave detection at a frequency of 5.8Ghz ± 15MHz. Detection radius angle from 30 ° to maximum 150 °. Maximum installation height is 12 meters. Operating ambient temperature from -20 ° to 50 ° C. Has an IP value of 20. The detector is provided with a screw and holder for mounting in a surface mounting box or mounting on fixtures (diameter screw thread = 2.1CM). Semko, CB, EMC, CE, R & TTE, SAA certified.

\* Available on the website

## Areas of application

Corridors / Industrial halls / Offices / Shops / Showroom / Classrooms / Meeting rooms / Storage

## Extra information

All information, specification texts, photos, technical drawings, connection diagrams, photometric .LDT files can be found via this clickable direct link: [https://www.voltron-lighting.com/product/EN/64/1229/LED\\_Eco\\_Smart\\_Controllers--SDS2](https://www.voltron-lighting.com/product/EN/64/1229/LED_Eco_Smart_Controllers--SDS2) or can be requested through your contact person.

## Direct link website



## Product barcode



The Voltron® name and logo as well as product names are part of the Voltron® Lighting Group and are protected by national and international laws.

The usage rights, reproduction rights as well as the intellectual rights are the exclusive property of the Voltron® Lighting Group.

Voltron® pays a lot of attention to the correctness and completeness of the information. However, it cannot be held responsible for any inaccuracy and / or omission. All images and texts are protected under copywrite law and may not be used or multiplied without express permission.