

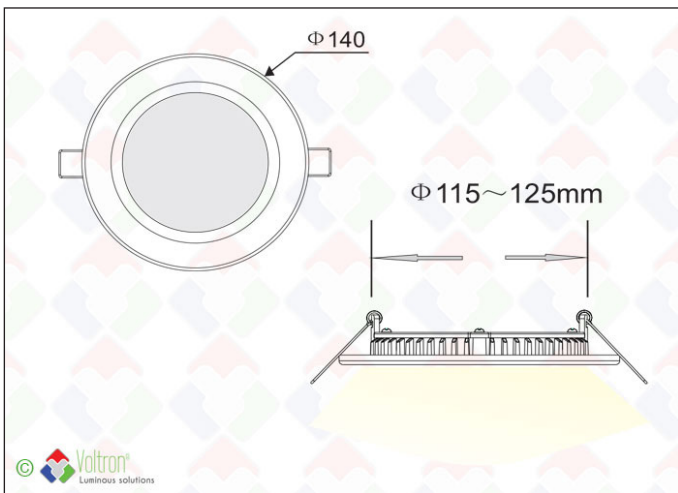













# The Flat Round



## TFR-140-WW-24V

The Flat Round by VOLTRON® is a round dimmable LED-downlighter for installation in false ceilings with ultra thin and light housing (only 26mm high!). ALU housing with lateral cooling fins for optimal cooling and long lifespan of the light output. The fixation in the ceiling is done with high-quality springs with extra protective rubbers. Electric connection is done with DC male/female connectors for very fast installation. The diffuse PC light surface ensures a smooth light distribution. This downlighter is also perfect suitable as a wall or floor lighting. TYPE TFR-140-WW : Ø140mm - 10W - 733Lm - 2700K - IP52 class - MacAdam 3 - white - HEIGHT = 26mm (!) - L80 >54.000h. Connectable to Meanwell power supplies (IP67) with constant voltage (not included). Warranty = 5 years.



 CCT 2700K	 WATT 10W	 IP 52	 Lumen 733Lm	 CRI Ra >85	 UGR <19	 Lx T: 25°C L80 >54.000
 MacAdam 3	 14CM	 11,5-12,5CM	 IK 03	 X	 DIMMABLE V	 GARANTIE 5

## Technical data

Productnumber	Barcode	CCT	IP value	Led chip
TFR-140-WW-24V	LH-1111	2700K	52	SMD2835
Voltage	Wattage	Diameter	Punch hole	Thickness
24V	10W	14CM	11,5~12,5CM	2,6CM
Finish color	CRI	Lxx @Ta=25°C	UGR	MacAdam
White	>85	L80 >54.000	<19	3
IK	Spread angle	Lumen	Dimmable	Driver included
03	120°	733Lm	V	X
Cable length	Constant voltage	Packed per		
31CM+33CM	V	2		

## Specification text\*

Highly efficient round dimmable LED downlight for installation in false ceilings with an ultra thin and light housing. White aluminum visible outer housing with cooling fin structure for optimum long-term operation. At the rear with removable high-quality ALU plate to promote the firmness and accelerated cooling of the LEDs. Fixation in the ceiling is done with 2 spring clips with plastic covered against cutting. Electric connection using DC male / female connectors for very fast assembly. The panel has 49 LEDs type Epistar SMD2835. Light control via opaque opal optic from PC for glare protection and maximum luminaire efficiency. Panel can also serve as wall or floor lighting. Dimensions outsideØ = 140mm, thickness 26mm and a weight of barely 185gr. Generates 10W and 733lm at 24V and a light color 2700K (white). IP52 class. IK 03, MacAdam 3, L80 >54.000, UGR <19. Extremely suitable for office spaces, meeting rooms, showrooms, shops, corridors, toilets and classrooms. Can be connected to Meanwell power supplies (IP67) with a constant voltage. With a color rendering index of > 85. Equipped with photo metric report and IES file for elaboration in DIALux.

\* Available on the website

## Photometric diagram



## Areas of application

Shops and showrooms / Toilets / Corridors / Installation vertically into walls as ground or wall lighting / Integration into false, gyproc or fixed ceilings / Private homes / Shipbuilding

## Extra information

All information, specification texts, photos, technical drawings, connection diagrams, photometric .LDT files can be found via this clickable direct link: [https://www.voltron-lighting.com/product/EN/55/1111/The\\_Flat\\_Round--TFR-140-WW-24V](https://www.voltron-lighting.com/product/EN/55/1111/The_Flat_Round--TFR-140-WW-24V) or can be requested through your contact person.

## Direct link website



## Product barcode



The Voltron® name and logo as well as product names are part of the Voltron® Lighting Group and are protected by national and international laws.

The usage rights, reproduction rights as well as the intellectual rights are the exclusive property of the Voltron® Lighting Group.

Voltron® pays a lot of attention to the correctness and completeness of the information. However, it cannot be held responsible for any inaccuracy and / or omission. All images and texts are protected under copyright law and may not be used or multiplied without express permission.